

Drawing ID

180J-S25X

**Product Info.**

Finish	Code
Polish	180J-S25M
Satin	180J-S25S
Texture Black	180J-S25B
White	180J-S25W
Brush Brass	180J-S25BB

Front View

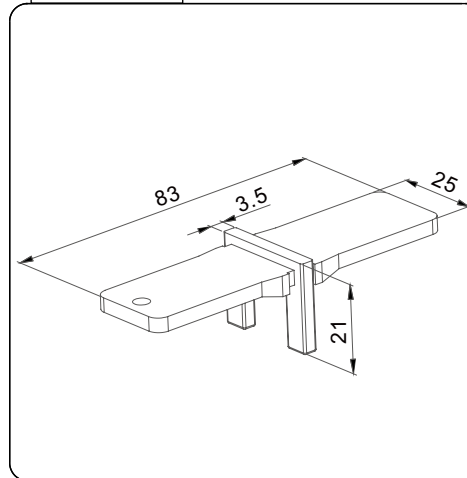

Instructions

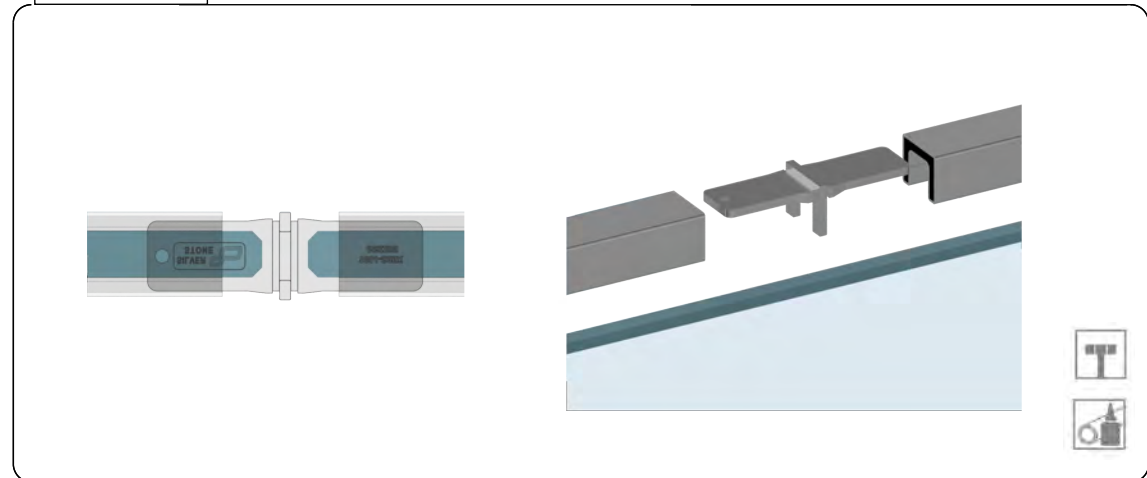

**MATERIAL:**

2205 Stainless Steel

**CATALOGUE AND DESCRIPTION:**

- > Railing Systems
- > TR-S25 Series
- > 180° Joiner

**NOTES:**

This drawing and or specification is the property of Silver Stone Hardware Pty Ltd - and must be returned to them on request. Unauthorised use may result in Legal Action. Its contents must not be made public, nor copied, nor used directly or indirectly in any way.

**SILVER STONE HARDWARE PTYLID**

56-62 Bryant Street, Padstow, NSW 2211  
 T: (02) 9792 2955 M: 0452 526 680  
[www.silverstonehardware.com.au](http://www.silverstonehardware.com.au)  
[sales@silverstonehardware.com.au](mailto:sales@silverstonehardware.com.au)